



Specifications

PVE 2804

Vibro Hammer

USA

Dimensions in inches

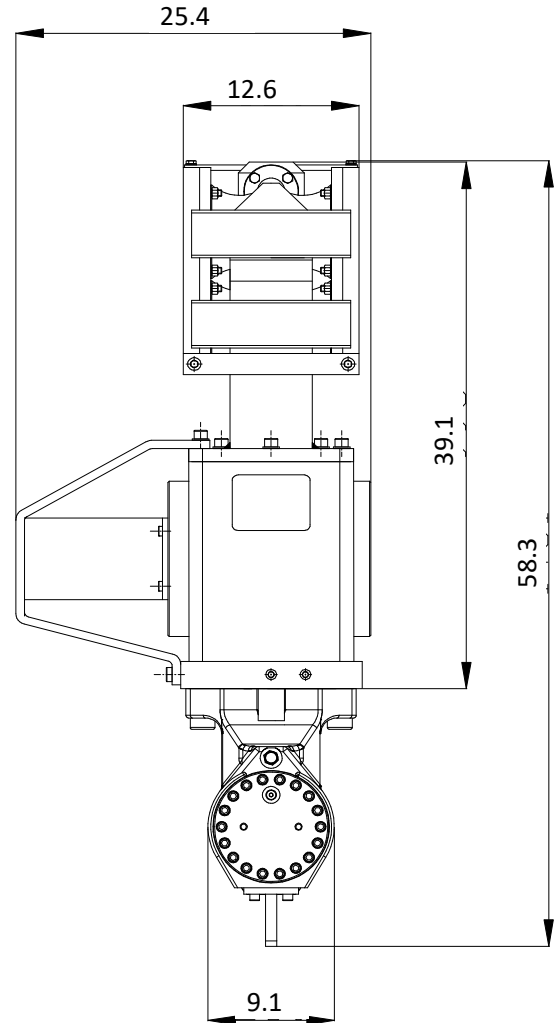
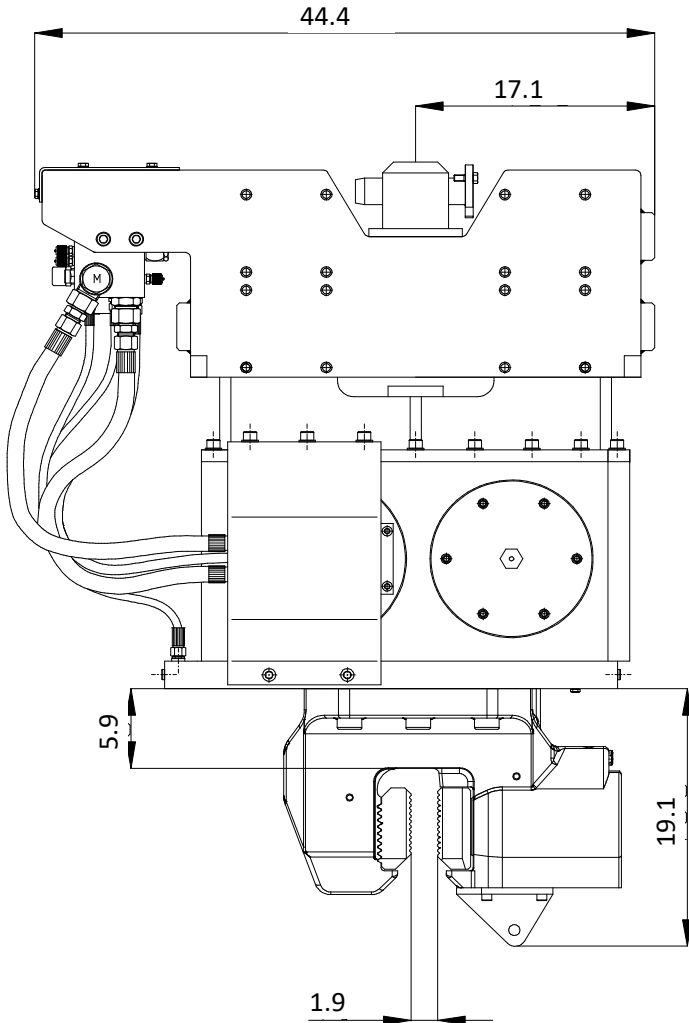

Specifications

PVE 2804

Eccentric moment	347 in-lbs	Clamps:	
Max. centrifugal force	39 ton	Sheet pile clamp	60TU
Max. frequency	2,800 rpm	Transport weight per piece	551 lbs
Max. amplitude excluding 60TU	0.48 in	Double clamps	N/A
Max. amplitude including 60TU	0.35 in	Transport weight per piece	N/A lbs
Max. static line-pull	12 ton		
Max. operating pressure	5,076 psi	Powerpack:	
Max. oil flow	44 gal/min	Model	N/A
Forced lubrication	no		
Dynamic weight excluding 60TU	1,433 lbs	Hose set:	
Dynamic weight including 60TU	1,984 lbs	Length	N/A ft
Total weight excluding 60TU & hoses	2,822 lbs	Transport weight (±)	N/A lbs